



WINDOWS BASED ON
VEKA PERFECTLINE 70 AD PROFILE

VEKA PERFECTLINE 70 AD



Windows based on Veka Perfectline 70 AD profiles are an ideal solution for customers who value quality and functionality while maintaining a lower price. Thanks to a wide range of options for glass packages, it is possible to customize windows to meet the current needs of multi-family and institutional construction. A 70 mm deep profile provides high thermal and acoustic insulation, resulting in comfortable use and energy savings.

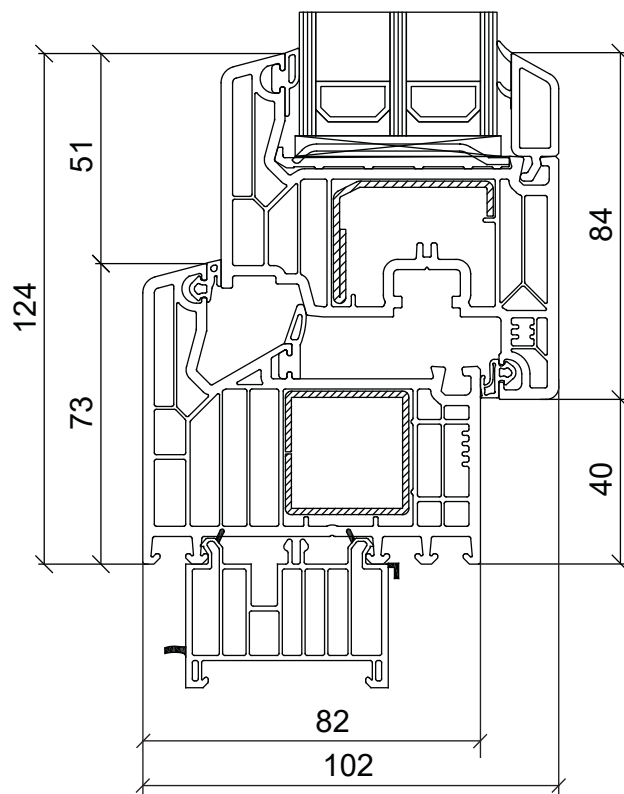
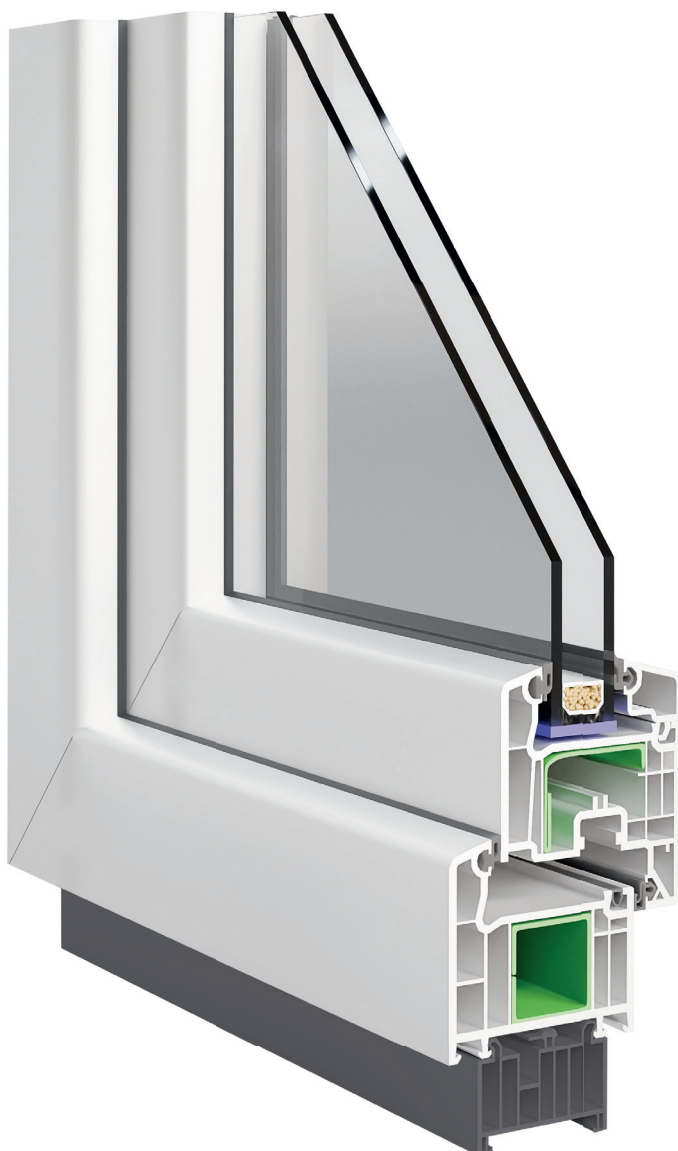

1,1

U_w (W/m²K) for glazing
 $U_g=1,0$ W/m²K

5/5

chambers (frame/sash)

2

seals

70

installation depth (mm)

A

class

CLASS UP TO
C5

wind load resistance according to EN 12210

CLASS
4

air tightness according to EN 12207

CLASS UP TO
9A

water tightness EN 12208

STANDARD FITTING



1. 2 SECURITY CATCHES

a minimum of 2 security strikers and rollers, which makes it more difficult to break in and increases the tightness of the structure

2. ADJUSTABLE TILT

ventilation intensity can be adjusted to the weather conditions

3. HANDLE MISALIGNMENT LOCK

increases the comfort of using the window and prevents the window sash from falling out of the top hinge

4. SASH LIFTER

facilitates the closing of large and heavy window sashes

5. THIN WELD

gives the window an elegant aesthetically-pleasing appearance

6. HINGES

standard with a load capacity of 100 to 130 kg depending on the size of the construction

7. HOPPE HANDLE WITH SECUSTIC SYSTEM

allows the window handle to be operated normally from the inside, but jams the handle if anyone tries to turn it from outside by way of the fitting

8. CLOSED REINFORCEMENT IN THE FRAME

standard profiles made of galvanised steel with a thickness of 1.5 mm to guarantee durability of the construction, but depending on the size of the construction stronger reinforcement can be used up to 2-3 mm thickness

9. PROFILE DEPTH

82 mm provides very good thermal insulation and energy saving performance

10. SWISSPACER WARM FRAME

with a very low heat transfer coefficient improves the overall window performance and increases the absorption of water vapour in the glazing units

11. ENERGY-EFFICIENT 3-PANE GLAZING

with low-emissivity film to increase thermal loss on cold days and protect against increased heat gain on hot days with $U_g=0,5 \text{ W/m}^2\text{K}$

12. SILL STRIP

to simplify window installation and the fitting of window sills

13. ANTI-DUST SEAL

protects the fitting groove against the accumulation of dirt and dust

14. CARRYING HANDLES

making it easier to transport windows on site

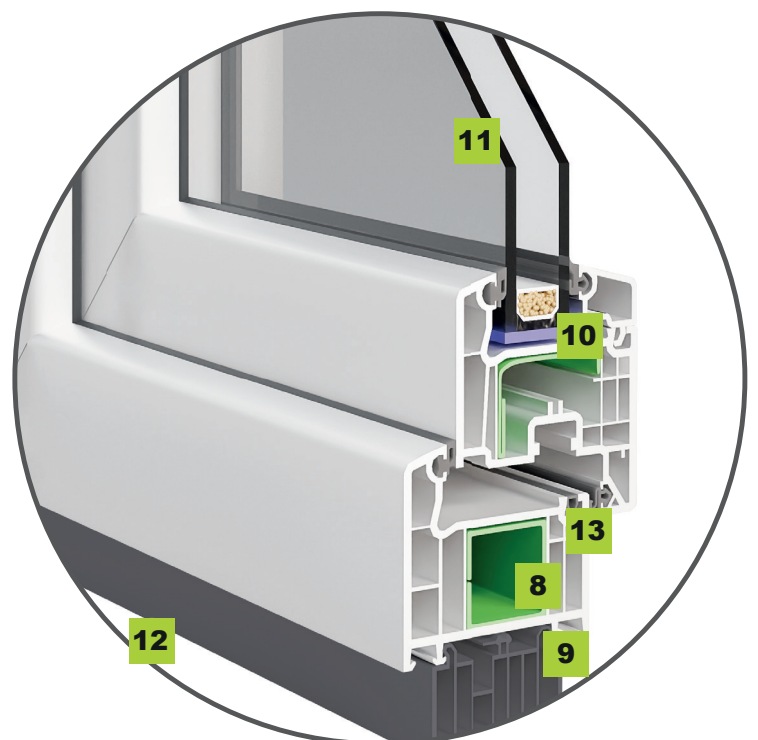

FITTING EQUIPMENT

	Normal + (Standard)	Styles	Protect (RC1)	Protect + (RC2)	MAX +
Modern and advanced Winkhaus Activ Pilot Concept fitting (normal+)	+	+	+	+	+
a minimum of 2 security strikers and rollers, which makes it more difficult to break in and increases the tightness of the structure	+	+	+	+	+
gradual tilt to adjust ventilation to weather conditions	+	+	+	+	+
handle misalignment lock increases comfort of use of the window, preventing, among others, the window sash from falling out of the upper hinge	+	+	+	+	+
sash lifter facilitates the closing of large and heavy window sashes	+	+	+	+	+
concealed hinges improve the aesthetic appearance of the window, make it easier to keep the window clean, improve tightness (no risk of gasket pressing), help with interior design as there are no additional elements to secure	-	+	-	-	+
4 security strikers and security rollers for increased burglary resistance	-	-	+	-	+
all security strikers and rollers (the number depends on the size of the window) significantly increase burglary resistance	-	-	-	+	-
anti-drill plate to minimise the risk of the structure being drilled open from the outside and the handle being twisted	-	-	+	+	+
special system dedicated to the children's room which prevents the window from opening but allows the sash to be tilted	OPTION	OPTION	OPTION	OPTION	OPTION
Safe+ reed relays	OPTION	OPTION	OPTION	OPTION	OPTION
handle with key or push button	OPTION	OPTION	+	+	OPTION
catch and lock balcony door	OPTION	OPTION	OPTION	OPTION	OPTION

SELECTED ADDITIONAL OPTIONS



ANTI-BURGLARY BOLTS
The octagonal bolt locking system is a perfect mechanism in terms of functionality



TILT-FIRST - SAFE CHILD
special system dedicated to the children's room which prevents the window from opening but allows the sash to be tilted

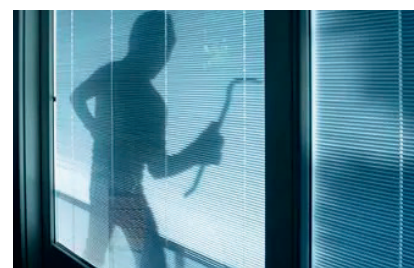

SAFE+ REED RELAYS
magnetic with direct connection to the control panel - the perfect solution for security-conscious people



HANDLE WITH KEY
provides a high degree of mechanical protection against burglary. A closed or ajar window is locked only by pressing the insert



HANDLE WITH BUTTON
to move the fitting, the button needs to first be pressed and then the handle turned. Like the Secustic® handle, it prevents windows from being opened from the outside

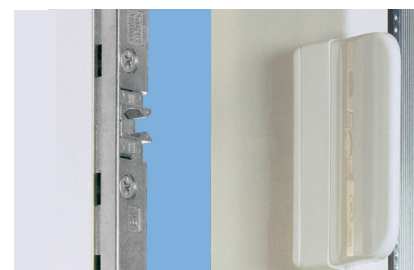

CATCH AND LOCK BALCONY DOOR
Allows you to close the door by pulling on the special handle. The lock will keep the sash in the frame, preventing drafts, hitting against the frame, and unintentional opening

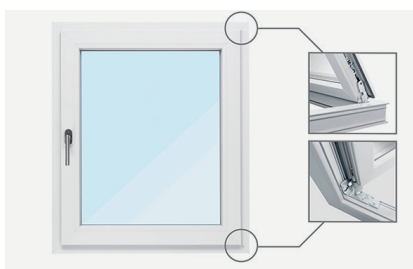

HIDDEN HINGES
protruding hinges have been replaced with special metal elements and are completely concealed in the small space between the sash and the frame



ORDINARY WINDOW PANE **ECLAZ**

ECLAZ® INSULATING GLASS UNITS
the use of ECLAZ glass has an effect comparable to an increase in the window area of 8 %, providing more light and up to 20% better energy balance of the window

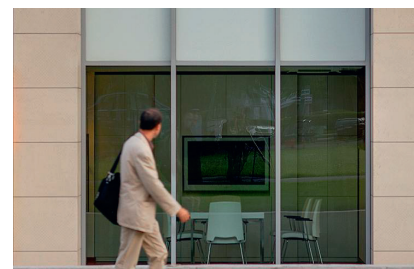

COOL-LITE SKN®
reduces the amount of solar energy that enters the room, resulting in reduced solar heat gain while maintaining a comfortable level of brightness